



NOVARA *

Elevação e
Treinamento



Adágio

Adágio

Adágio promove ergonomia e movimento no ambiente de trabalho, ideal para estações ativas e dinâmicas.

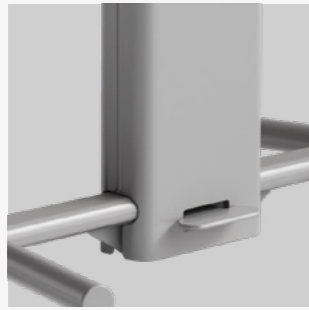

Sistema de travamento



Estrutura metálica



Tampo rebatível



Sistema de regulagem que permite alternar entre posições sentadas e em pé.

Trabalhar com mais liberdade



Integra-se a diferentes linhas de mesas e layouts com leveza e funcionalidade.

Ideal para espaços corporativos voltados ao bem-estar e dinamismo.





6 Estrutura metálica

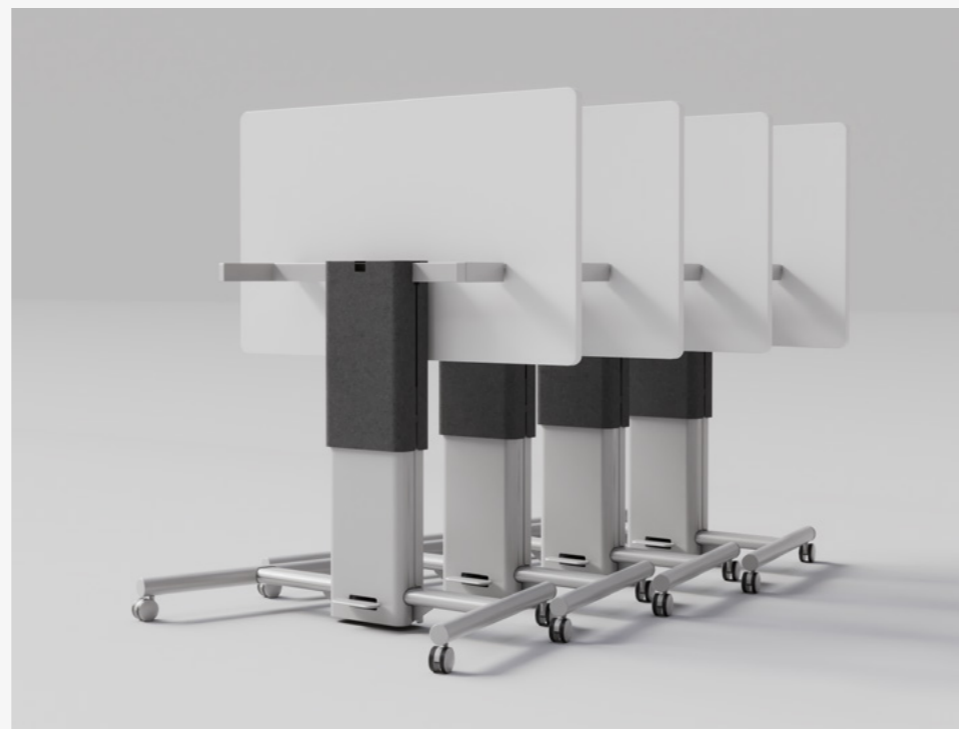

Tampo rebatível



Sistema de travamento

Configurações

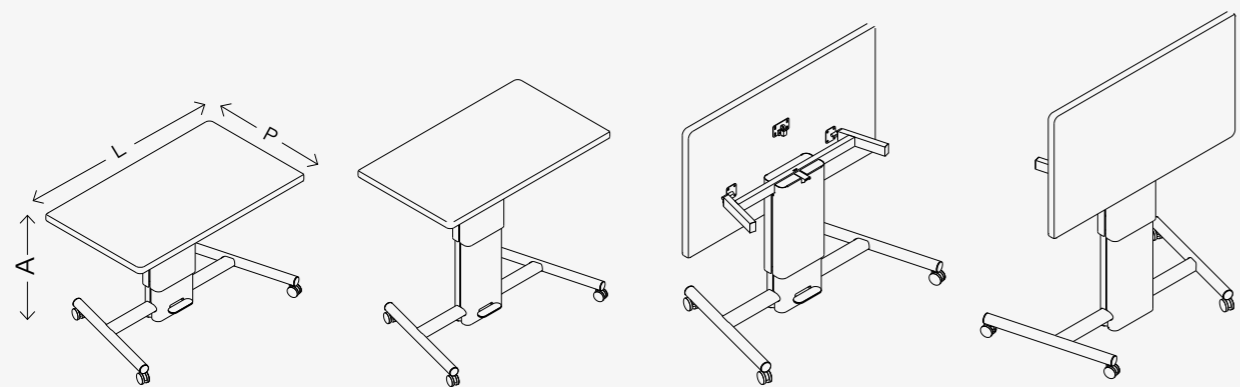

Dimensões

Largura (mm): 1000, 1200, 1400
Altura (mm): 750, 1050
Profundidade (mm): 700
Carenagem opcional



Ópera

Ópera

Ópera é voltada à ergonomia, unindo resistência e leveza visual. Ideal para salas de aprendizado e capacitação, suas mesas permitem fácil movimentação e organização, com diversas opções de layout.



Sistema de divisores



Regulagens independentes



Sistema de elevação



Funcionalidade e integração para estações de trabalho dinâmicas e conectadas.

Formação com fluidez e eficiência



Ambientes educacionais, workshops, salas multiuso e espaços corporativos de formação



Opções de tamanhos, alturas e acabamentos, podendo ser combinadas em diferentes formações.



14 Sistema de conectividade



Regulagem independente



Sistema de travamento

Mesa dupla

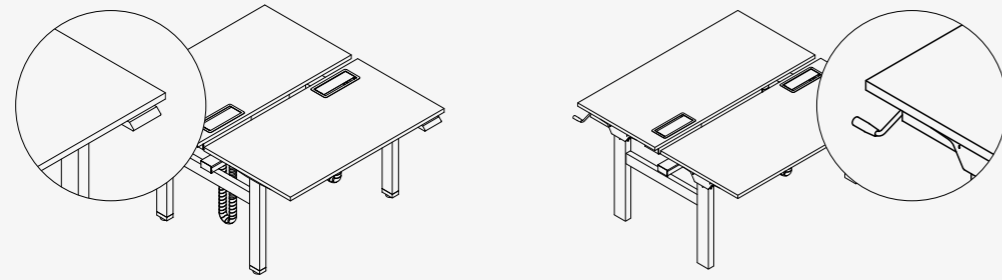

Elétrica

Manual

Dimensões | Largura (mm): 1200, 1400, 1600
 | Altura (mm): 730 a 1200
 | Profundidade (mm): 1400, 1600

Mesa simples

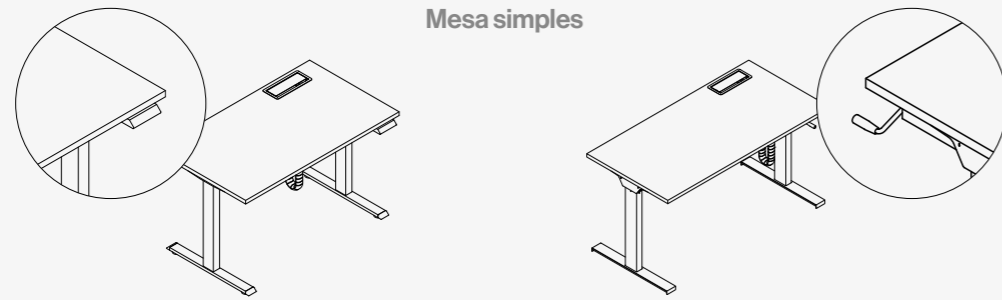

Elétrica

Manual

Dimensões | Largura (mm): 1200, 1400, 1600
 | Altura (mm): 730 a 1200
 | Profundidade (mm): 800, 1400

Conectividade

Caixa de tomadas

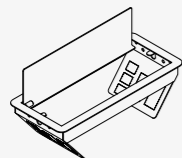

Passa cabos

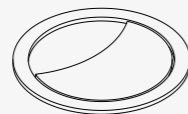

PlugPlay

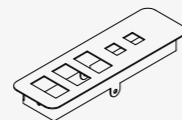

Painel Divisor Frontal

(MDP BP, MDF Pintura, Tecido, Vidro Incolor, Vidro Branco, Vidro Jateado)

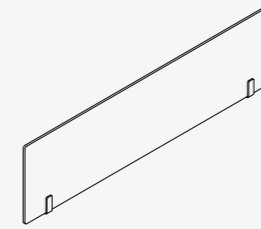

Dimensões | Largura (mm): 1200, 1400, 1600
 | Altura (mm): 325 (350 acima do tampo)
 | Profundidade (mm): 6, 8, 15, 18

Calha Inferior para Mesa Simples

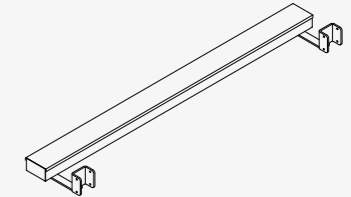

Dimensões | Largura (mm): 1200, 1320, 1520
 | Altura (mm): 45
 | Profundidade (mm): 80

União de Calha

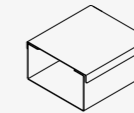

Dimensões | Largura (mm): 92
 | Altura (mm): 45
 | Profundidade (mm): 80

Duto Mesa Simples e Dupla Fixo na Calha

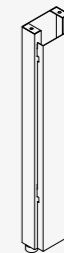

Dimensões | Largura (mm): 80
 | Altura (mm): 480
 | Profundidade (mm): 45

Duto Lateral Mesa Simples Fixo no Pé



Dimensões | Largura (mm): 50
 | Altura (mm): 570
 | Profundidade (mm): 35



Cartolina

Cartolina

Cartolina é pensada para ambientes educacionais, treinamentos e workshops. Leve, resistente e funcional, permite fácil movimentação e configuração dos espaços. Ideal para uso intensivo com praticidade e visual alinhado ao mobiliário corporativo.



Tampo rebatível



Sistema de conectividade



Funcionalidade e integração para estações de trabalho dinâmicas e conectadas.

Formação com fluidez e eficiência



Ambientes educacionais, workshops, salas multiuso e espaços corporativos de formação



22 Estrutura metálica



Modularidade



Sistema de conectividade

Configurações

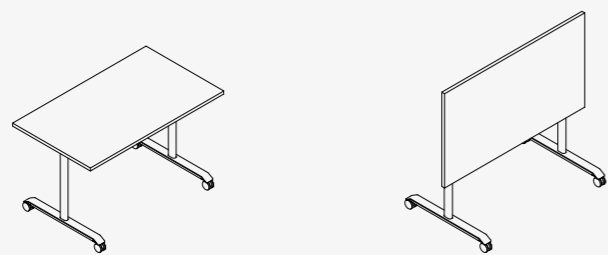
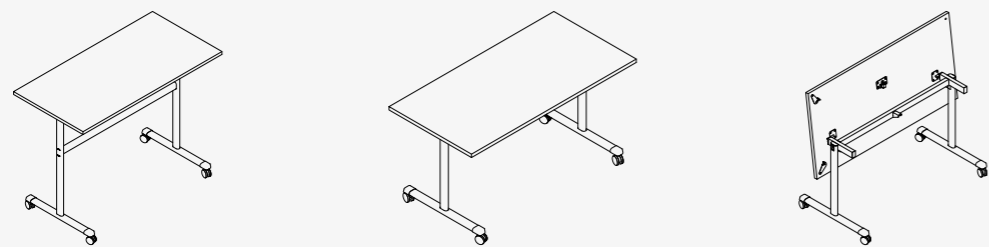

Dimensões | Largura (mm): 1000, 1200, 1400, 1500 e 1600
Altura (mm): 730, 1050
Profundidade (mm): 600, 700 e 800

MATERIAIS

MDP BP LISO



MDP BP MADEIRADO

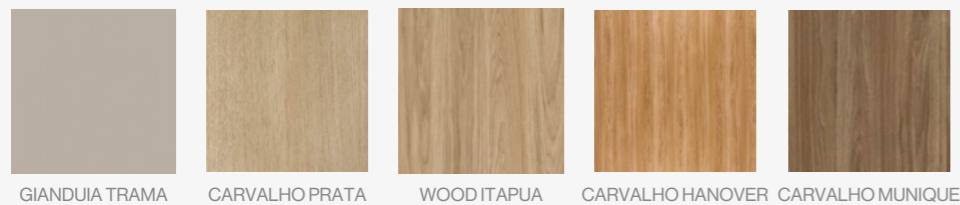

EPOXI LISO

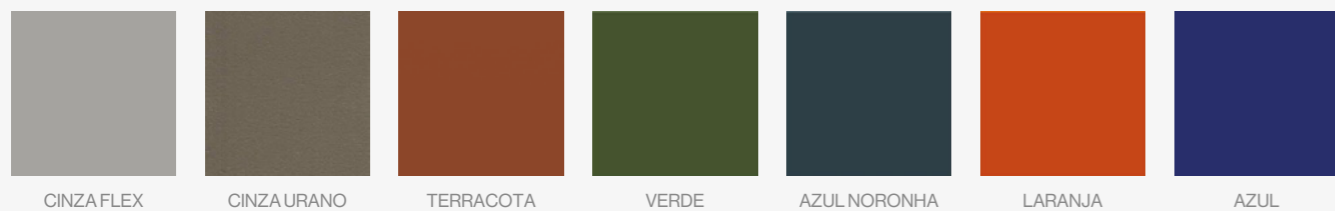

EPOXI MICROTATURA

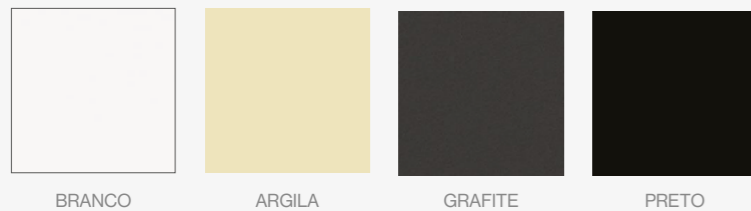

PINTURA GOFRATO (APENAS PARA DIVISORES)

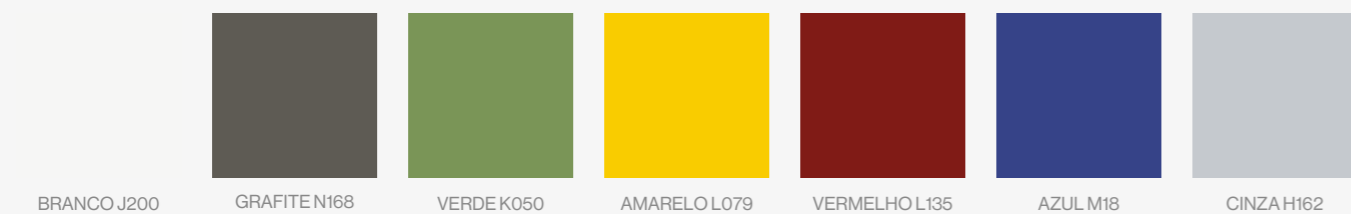

TECIDOS POLIÉSTER CREPE (APENAS PARA DIVISORES)



TECIDOS FUSION



TECIDOS POLITEX FELTRINHO



TECIDOS PRIME



VIDROS

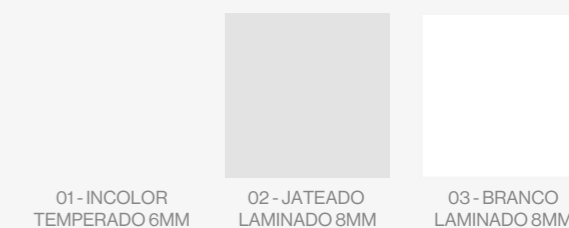

NOVARA *

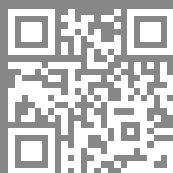

www.novara.ind.br

R. Evaristo de Antoni, 3013 - Caxias do Sul - RS